



PINNGUAQ



STITCHES & SWITCHES

EXPLORING AND BLENDING SEWING WITH TECHNOLOGY



a program brought to you by
THE PINNGUAQ ASSOCIATION

Table of Contents

INTRODUCTION

- 03** Welcome Message
- 04** Inuit Qaujimagatuqangit
- 05** What's Inside / Getting Started

ACTIVITIES

- 07** Paper Circuits
- 13** Intro to Sewing and Circuits
- 21** Make Your Own Electrical Switch
- 34** Beading & Circuits: Floral Design
- 46** Beading & Circuits
- 56** Stories in the Sky!



Welcome!

CONGRATULATIONS ON TRYING THE ONE AND ONLY “STITCHES AND SWITCHES” KIT.

These activities explore and blend sewing and technology to get creative with electronic circuits. E-Textiles allow you to customize fabric and material with digital components like LED lights to light up your clothes and computer chips to add code. If you are new to circuits and sewing – do not worry!

There are beginner-friendly activities to guide you through the basics. Or, if you just need to refresh your memory, some advanced projects explore more complicated circuits and introduce new components if you’re looking for a challenge.

We hope you will be inspired to tell a story; we’d love to hear it! Flaunt your flashy outfits/ creations and share them with us by tagging [@Pinnguaq](#) and posting [#LearnWithPinnguaq](#). Can’t wait to see what you do!

Keep shining bright,
Your Friends at Pinnguaq



Inuit Qaujimajatuqangit

“THINGS OF WHICH INUIT KNEW ABOUT ALL ALONG”

Inuit knowledge was developed over a very long period and allowed Inuit to thrive on the land and live a good, healthy life. This wisdom comes from experience and is passed down to the next generation.

SOME IQ CONCEPTS THAT WILL BE EXPLORED IN THIS LESSON ARE:

Pijitsirarniq: The concept of serving and providing for family and/or the community.

Aajiqatigiingniq: The concept of making decisions through consultation.

Pilimmaksarniq: The concept of developing skills through observation, mentoring, practice, and effort.

Qanuqtuurungnarniq: The concept of being innovative and resourceful.

Piliriqatigiingniq: The concept of collaborative relationship or working together for a common purpose.

Avatimik Kamattiarniq: The concept of Environmental Stewardship.

At the end of each activity, we invite you to reflect on what you learned and how you can solve any problems you might encounter. Reflecting on elements of Inuit Qaujimajatuqangit will help us to understand how to approach different situations or problems. More information and resources about Inuit Qaujimajatuqangit can be found on the links/USB drive provided.

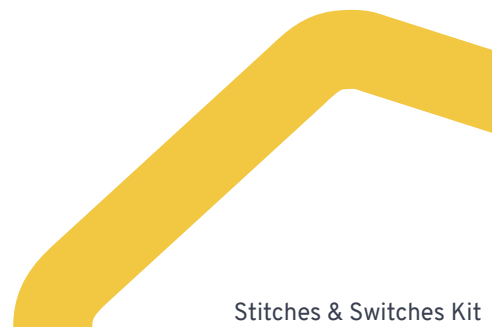

WHAT'S INSIDE

E-TEXTILE MATERIALS

- A flash drive with the activity guide and resources
- A LilyPad E-Sewing Kit, with:
 - Needles
 - Conductive thread
 - Electronic components
- A Lily-Tiny; to make the lights twinkle, flash, and fade
- Conductive tape
- Conductive Fabric

EXTRA TECH

- Lilypad LEDs
- Batteries
- Battery holder
- Wires
- Electronic components

CRAFT SUPPLIES

- Fabric
- Beading needles and beads

+ A COPY OF ROOT & STEM

GETTING STARTED



On the USB flash drive provided, you will find the activity guide with all the instructions for each project.

➔ [Stitches & Switches Activity Guide.pdf](#)

Other helpful resources you might need can be found within this flash drive as well.

HOW TO USE A USB FLASHDRIVE

- 1 Start your computer and insert the flash drive into a USB port on your computer. You can find USB ports on the front, back, or sides of your computer.

2

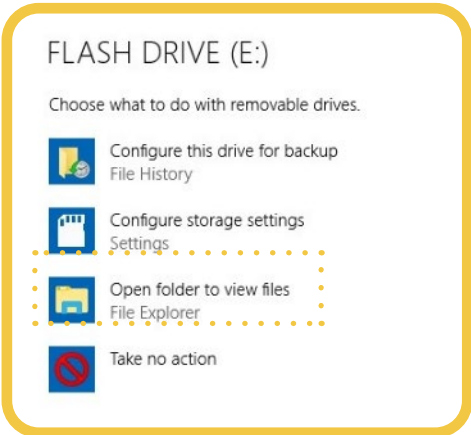

Once you have successfully plugged in the flash drive, a dialogue box should appear. Click “Open folder to view files.”

3

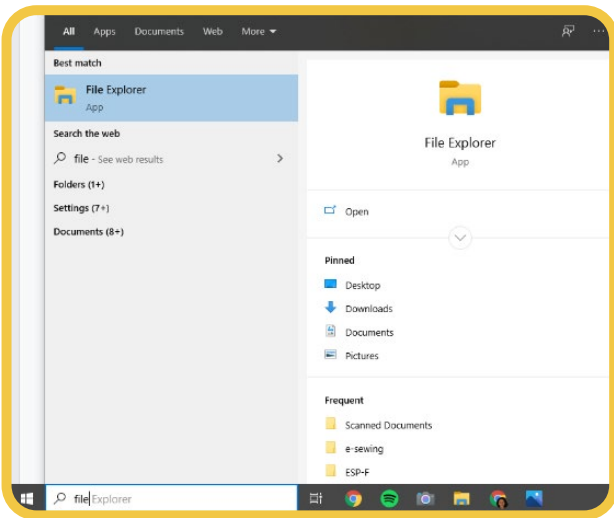

If A dialog box does not appear, type “File Explorer” in the bottom left corner.

4

Select it and then locate the flash drive in the menu on the left. Click “This PC” to expand the drop-down menu; the flash drive should be here. Click to open the files on the flash drive and find the Stitches & Switches Activity Guide.pdf to start a project.

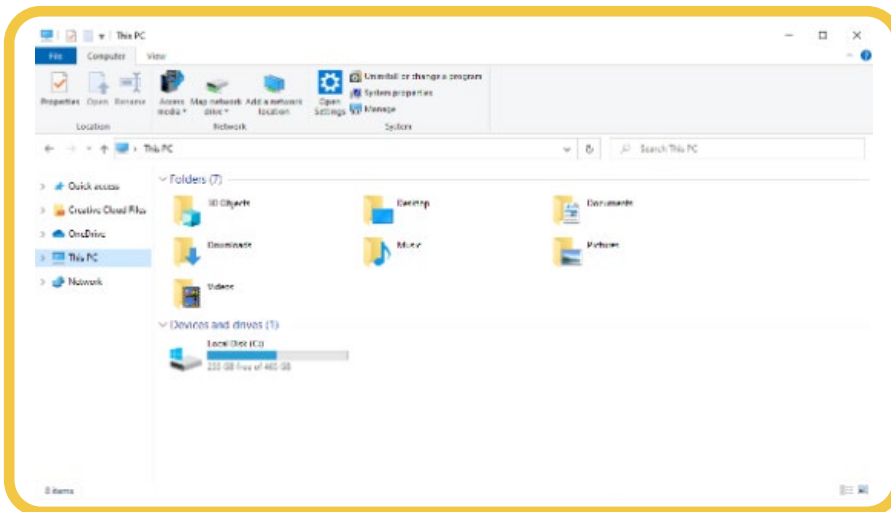

Paper Circuits

LEARN THE BASICS BY MAKING A CIRCUIT USING PAPER AND CONDUCTIVE TAPE.

i BEFORE YOU START

LEARNING GOAL(S):

- Understand circuit diagrams
- Recognize the components in a circuit
- Understand how electricity moves through a closed circuit.

SUCCESS CRITERIA:

- You can solve problems related to circuits
- You can make a functional paper circuit with a power source and an LED

MATERIALS:

- 1x Coin Cell Battery
- 1x LED
- Copper Tape

VOCABULARY

Electricity can take two forms: **static electricity**, and **current electricity**.

A circuit: In electronics, a circuit is a closed path that allows electricity to flow from one point to another and credit.¹

A conductor: a material that allows electricity to flow through a circuit. For example, the copper tape is a great conductor.

A power source: supplies electricity to the circuit. *(For example, a battery is a power source.)*

Components: in a circuit, each component uses the electricity provided by the battery. They do different things in a circuit.

1 <https://techterms.com/definition/circuit>

ESSENTIAL QUESTIONS FOR ACTIVITY

Q: How does power flow through a circuit? Conductive copper tape.

Q: How do I control the flow of electricity? You can use a switch.

MINDS-ON

Have you ever felt a shock when you go to open a door or turn on the lights, or even someone else? This is an example of **static electricity** building up on your body. When you touch something metal, like a doorknob, the static electricity that you receive from the environment creates a negative charge on you and wants to move away from you. How does electricity travel? Electricity can be very lazy and wants to move through materials that make it easy for it to move from one place to another. Metal doorknobs are a great example of **conductors** of electricity. When your finger gets close enough to something conductive (a metal) the static electricity moves very quickly away from you to the metal object, and that's why you feel a shock!

LET'S GET STARTED!

 ACTION

- 1 **Understanding the Components:** You will need these components: a battery, copper tape and an LED.
- 2 Look at the battery, notice how there are two sides, one side is positive (+) and one is negative (-).
- 3 Look at the LED, notice how there is also one positive (+) and one negative (-) side.
- 4 Look at the copper tape, what do you notice about it? How does it feel or look? The copper tape has two sides, one is shiny and the other side is meant to stick to something. What material is copper made of? Copper is a metal and a conductor, it will help electricity travel from the battery to the LED.
- 5 **Applying the Components:** Here, you will create a path for electricity to travel using conductive copper tape. Use the diagram below to draw your own circuit diagram and you will use it to place the components.

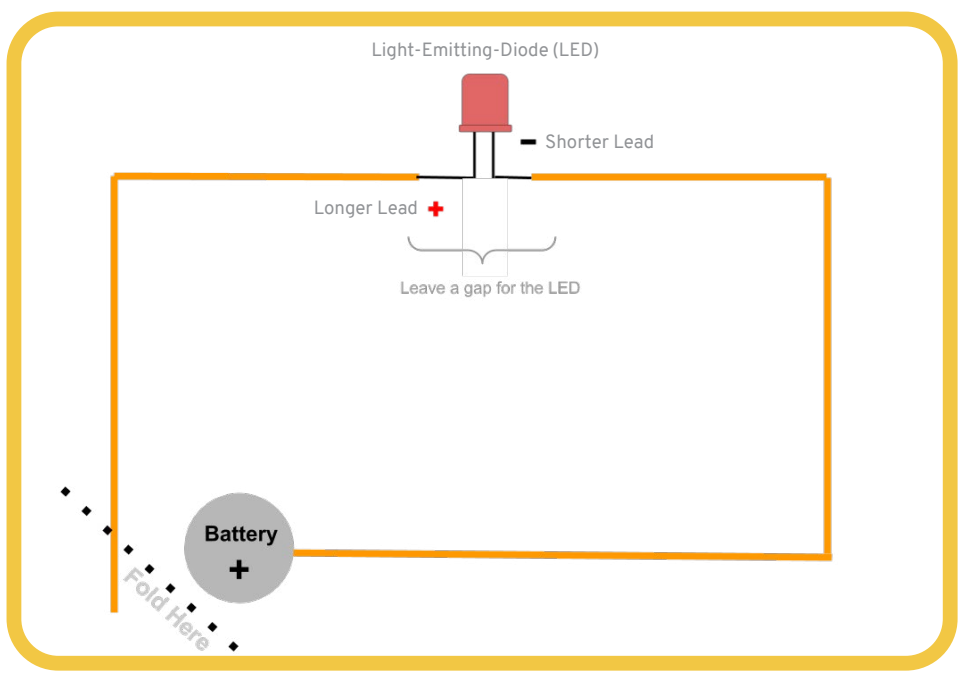

A Unroll some copper tape and stick it along the diagram, make sure to follow the lines.

B When you get to the corners, fold the copper tape on itself.

C Leave space for the LED. Cut the copper tape and leave a gap. Continue to stick the copper tape until the end of the diagram.

6 Next, place the LED in the circuit. Since electricity travels in one direction, we will need to find the negative side of the LED.

A Place the LED where you left a gap.

B Make sure the negative side of the LED is touching the copper tape that is connected to the battery. The positive side should be directed at the end of the circuit. Current flows through a circuit from the negative (-) to the positive (+) terminals.

C Secure the LED with regular, clear tape.

7 **Add the Power Source:** Finally, add the battery to the circuit. The copper tape needs to touch the negative (-) side of the battery. So the positive (+) side will be facing up.

8 **Congratulations!** You made a paper circuit! You have a conductor, a power source, and an LED. They are all connected and the electricity has a clear path to travel, but why isn't the LED lighting up? This is because you haven't completed the circuit. Electricity will only travel through a closed circuit from a negative terminal to a positive terminal.

A Look at the end of the copper tape after the LED. It isn't anything connected to anything.

B Fold the paper circuit on itself so the end of the copper tape touches the positive end of the battery.

C The LED should light up through the hole.

QANUQTUURUNNARNIQ

QANUQTUURUNNARNIQ

Being resourceful to solve problems.

- Without folding the paper circuit, how else could we close the circuit and make the light shine?
- What can we add to the circuit to connect the copper tape to the exposed face of the battery?
- What objects conduct electricity?
- How else could you make this circuit if you weren't sticking the copper on to paper?
- What could you use instead?
- How would you connect and break the circuit to make the light come on and off?
- Can you recreate this circuit using the wires with alligator clips?

POST-LESSON REFLECTIONS

- What worked?
- What didn't, and why?
- What to change for next time?

RESOURCES

What is Electricity?

<https://learn.sparkfun.com/tutorials/what-is-electricity/all>

Why do I Get an Electric Shock?

<https://kidshealth.org/en/kids/electric-shock.html#:~:text=If%20you%20scuff%20your%20feet,metal%2C%20which%20scientists%20call%20conductors.&text=That%20tiny%20shock%20you%20feel,quick%20movement%20of%20these%20electrons.>

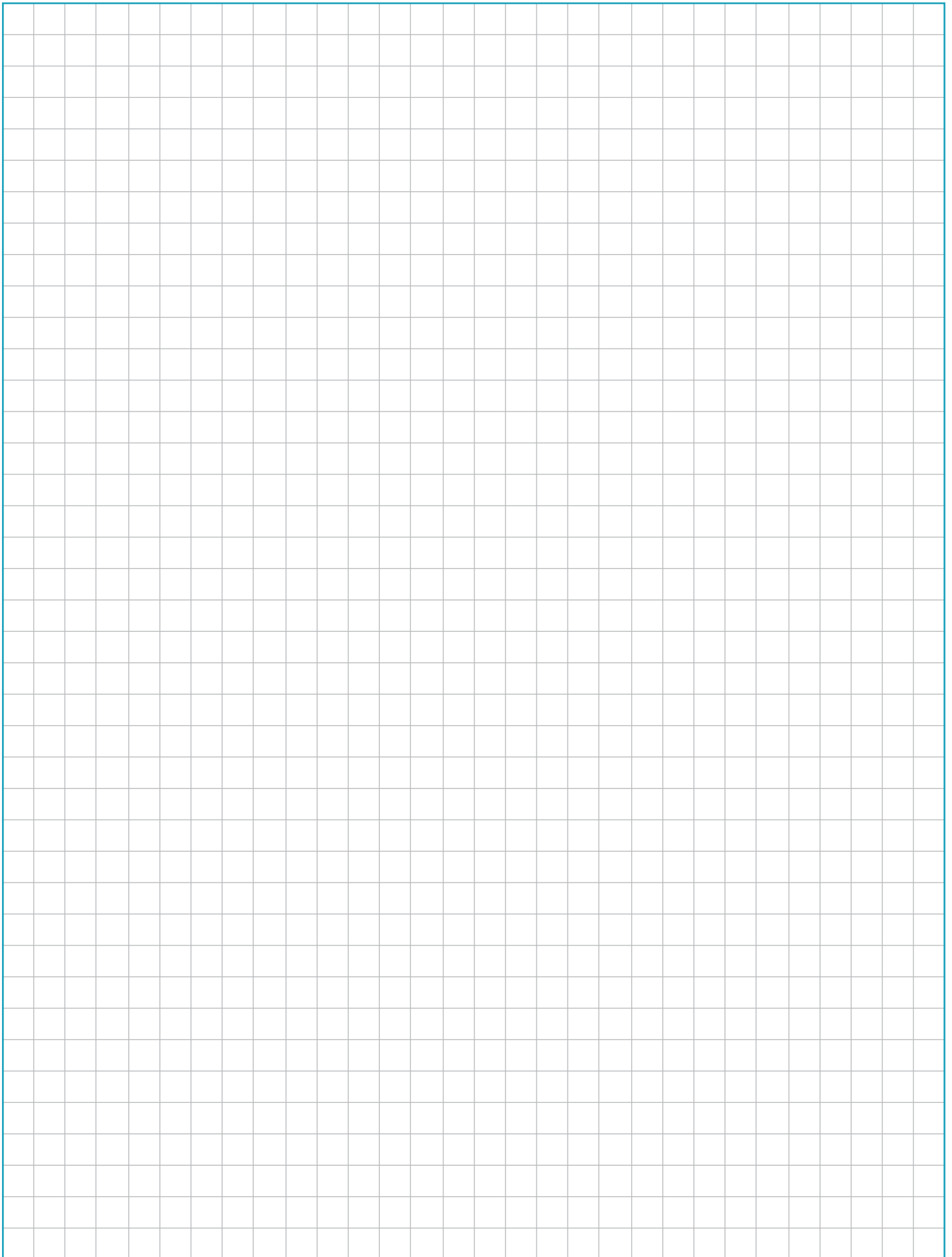

Intro to Sewing & Circuits

IN THIS ACTIVITY, YOU'LL LEARN ABOUT HOW BASIC ELECTRONIC COMPONENTS WORK.

You'll also learn about how to use conductive thread and stitchable components. These skills can be used to stitch circuits onto clothing, fabric and other material.

i BEFORE YOU START

LEARNING GOAL(S):

- Experiment with the Lilypad ESewing Kit
- Recreate the Lilypad ESewing Kit circuit on fabric
- Extension: modify the circuit to make all lights come on with one switch.

SUCCESS CRITERIA:

- You are able to install the battery to power the circuit
- You can use switches to control the lights in the lilypad circuit
- You can recreate the lilypad circuit using alligator clips and conductive thread then test that it works
- You can troubleshoot problems in your circuit

MATERIALS

LilyPad E-Sewing ProtoSnap Kit:

- 1x LilyPad E-Sewing ProtoSnap
- 1x Conductive Thread Bobbin, Gray Thread
- 1x Coin Cell Battery – CR2032
- 1x Needle Set
- 1x White Felt – 100 Square Inch

VOCABULARY

Light Emitting Diode (LED): the electronic component used as a light in our circuit.

Conductive Thread: thread that allows electricity to travel along it. Great for making wearables!

ESSENTIAL QUESTIONS FOR ACTIVITY

Q: How are the components connected on the lilypad? Conductive copper track on the circuit board.

Q: If we break apart the components of the lilypad to use them, how will we connect them?
Conductive thread!

Q: Which components need to be connected with the right polarity? Battery, Light Emitting Diodes (LEDs)

MINDS-ON

THINKING ABOUT SWITCHES AND POWER

- Go to the nearest light switch and flick it. What happened?
- Flick it again, what happened now?
- What happens inside the switch to make the light go on and off?
- Where does the power for the lights come from?
- How else can lights be powered?

LET'S GET STARTED!

 ACTION

- 1 Unpack the Lilypad E-Sewing Protosnap Kit.
- 2 Take a look at the Lilypad circuit board, what components can you see? How many switches are in the kit? Which components can light up?

- 3  Install the battery into the battery holder on the Lilypad circuit board, making sure that the positive (+) side is facing up.

- 4 Turn on the switch by the battery. What happens?
- 5 What happens when the other switches are pressed?



- 6 The components of the lilypad board can be broken apart to stitch into projects. We can join these components with any conductive material. Twist and break your lilypad components away from the board to separate them.

7 We will use the circled components in the next step.



8 Try recreating the circuit below by joining the circled components with alligator clips. Pay attention to the orientation of the LEDs and battery. Be sure to connect the positive (+) side of the LED to the positive (+) of the battery. If they are connected backwards the circuit won't work. To test, make sure the switch on the battery is on, then turn the other switch in your circuit on!

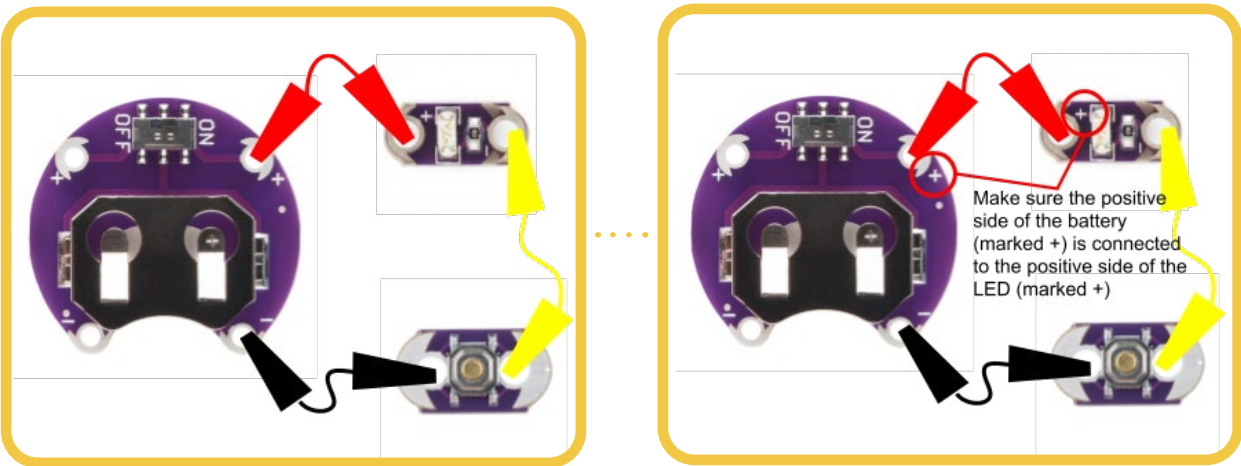

9 If you want to make changes to your circuit like adding more lights, or trying a different type of switch – now is the time to try it! If you make your own circuit, don't closely follow the steps below.

- 10 Take a picture or draw a sketch to remind yourself of how your circuit is connected (or, refer to the picture above), remove the battery and the alligator clips and stitch the components on to the felt fabric with the conductive thread included in the kit. Be sure to cut any loose ends short, as loose ends can become short circuits and stop our projects from working. Replace the alligator clip connections with stitches of conductive thread, replace the battery and test your circuit!

11



Attach the battery holder, stitch a knot and make several loops to secure.

12

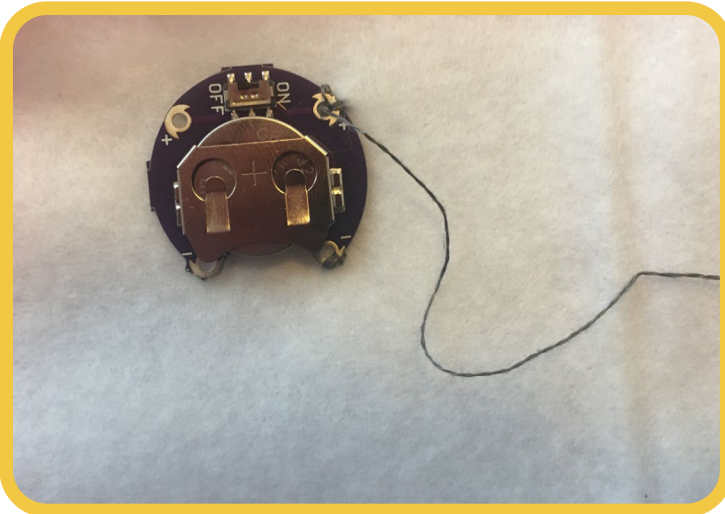

Keep the working end of the thread attached.

13



Make running stitches and join the positive + side of the LED to the felt. Tie off and cut the thread when you are done.

14

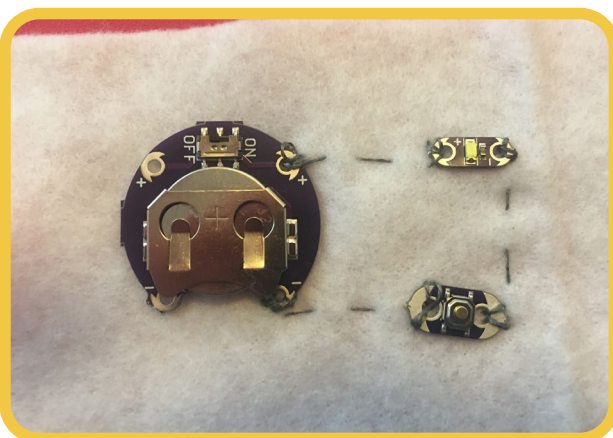

Make a knot and join the negative - side of the LED to the felt, with running stitches going to the button switch. Tie off again and cut. Tie a knot again on the other side of the switch, with running stitches going to the negative - of the battery. Tie off and cut the thread.

15

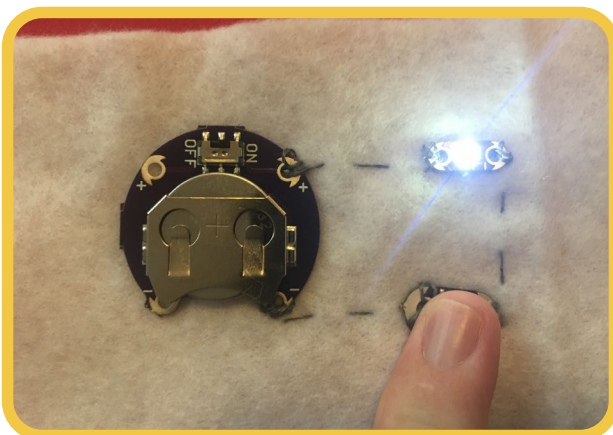

Test your circuit! Make sure the battery is in with the + sign facing up, make sure the switch on the battery holder is on, then press your button switch to turn on the LED light! If your circuit doesn't work, check closely for loose threads on both sides of the felt, and cut them short. Make sure the components are tightly attached with conductive thread.

? PILIMMAKSARNIQ

The concept of developing skills through observation, mentoring, practice, and effort.

WHAT SKILLS AND KNOWLEDGE DID YOU ACQUIRE DURING THIS PROJECT?

- What did you learn?
- Can you name some conductive materials?
- Which components of the circuit need to be connected with the right polarity?
- Are there components whose polarity doesn't matter?
- Where does the electrical power come from?

POST-LESSON REFLECTIONS

- What worked?
- What didn't, and why?
- What to change for next time?
- What other materials might work to stitch this circuit on to?
- What types of materials have the lowest impact on the environment, and why?
- How could you build this circuit into something you might wear?
- How could I use the conductive thread to make a necklace?

📖 RESOURCES

ONLINE

LilyPad Basics: E-Sewing

<https://learn.sparkfun.com/tutorials/lilypad-basics-e-sewing>

LilyPad Basics: E-Sewing Troubleshooting

<https://learn.sparkfun.com/tutorials/lilypad-basics-e-sewing/troubleshooting>

BOOKS

Make: Wearable Electronics, 2014, Kate Hartman

PDF Lilypad Guide:

<https://drive.google.com/drive/u/0/folders/1deMUq4ZNB2ngicJfNEfd-6fCvR4CX7ZN>

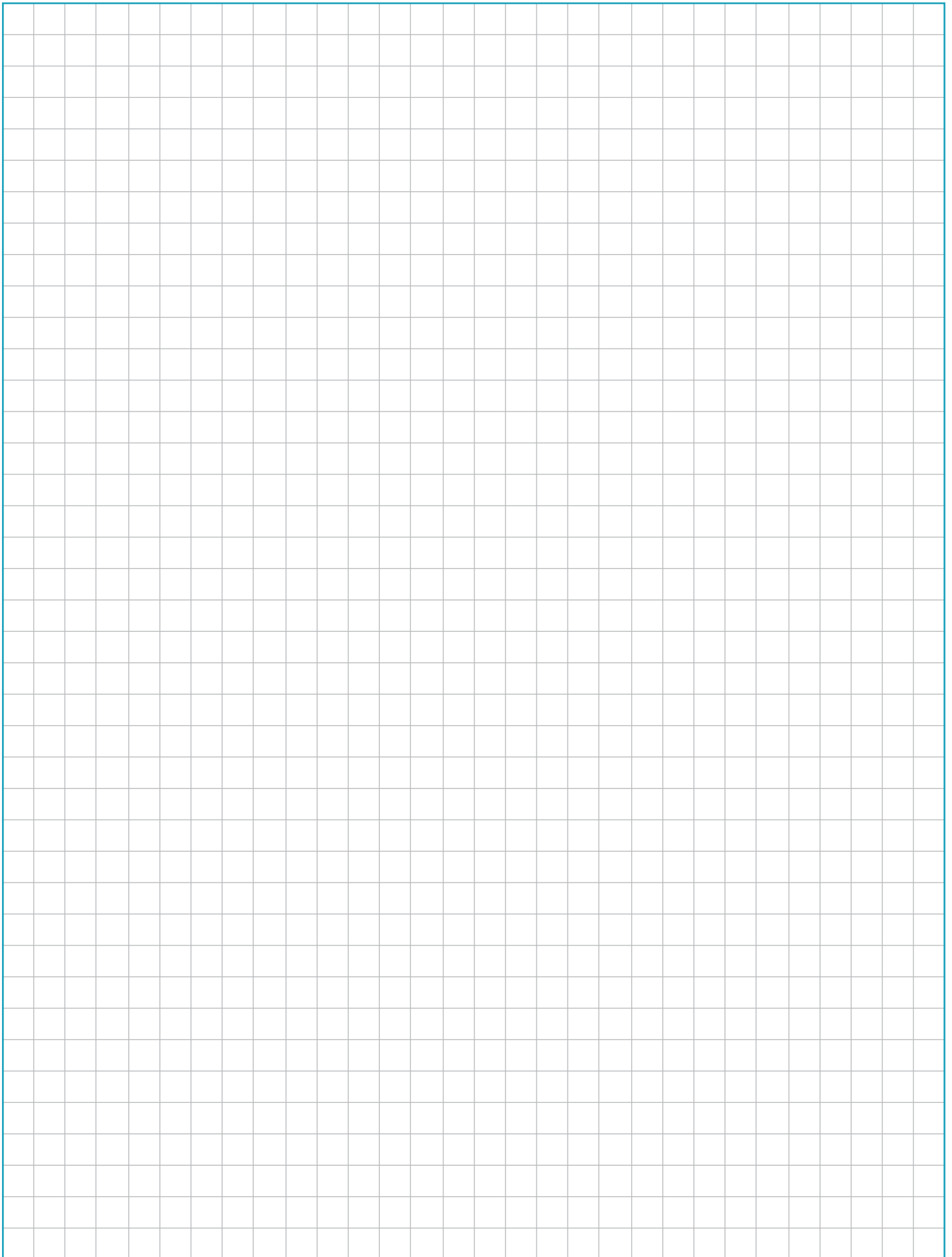

Make Your Own Electrical Switch

IN THIS ACTIVITY, YOU'LL LEARN ABOUT HOW SWITCHES WORK.

Then, you will create your own switch using felt and conductive fabric. This type of soft switch is great for making your own wearable circuits.

i BEFORE YOU START

LEARNING GOAL(S):

- Understand how an electrical switch works
- Create a basic 'sandwich switch' that can be incorporated into a wearable project

SUCCESS CRITERIA:

- You can recreate a basic circuit with the lilypad components
- You can create a wearable switch using conductive fabric, regular fabric and basic stitching
- You can integrate the wearable switch into the circuit and test it!

MATERIALS

- Lilypad Battery Holder
- Lilypad Button Switch
- Alligator Clip Wires
- Needles
- Nylon Thread
- Scissors
- Conductive Fabric
- Felt or other regular fabric

VOCABULARY

Switch: A switch is a component which controls the open-ness or closed-ness of an electric circuit. They allow control over current flow in a circuit (without having to actually get in there and manually cut or splice the wires). Switches are critical components in any circuit which requires user interaction or control.

ESSENTIAL QUESTIONS FOR ACTIVITY

What does a switch do to our circuit when it is 'off'?

What does a switch do to our circuit when it is 'on'?

MINDS-ON

What is the quickest way to turn off an electrical device if you can't get to the switch? Disconnect it from the power by pulling the plug!

A switch is a device that can make (or break!) the connection in our circuit. This is how a switch turns a device on or off- by connecting or disconnecting it from the power source.

LET'S GET STARTED!

 ACTION

- 1 First, let's build a basic circuit with a battery, a switch and an LED. Connect the components with alligator clips, then insert the battery and test the circuit.

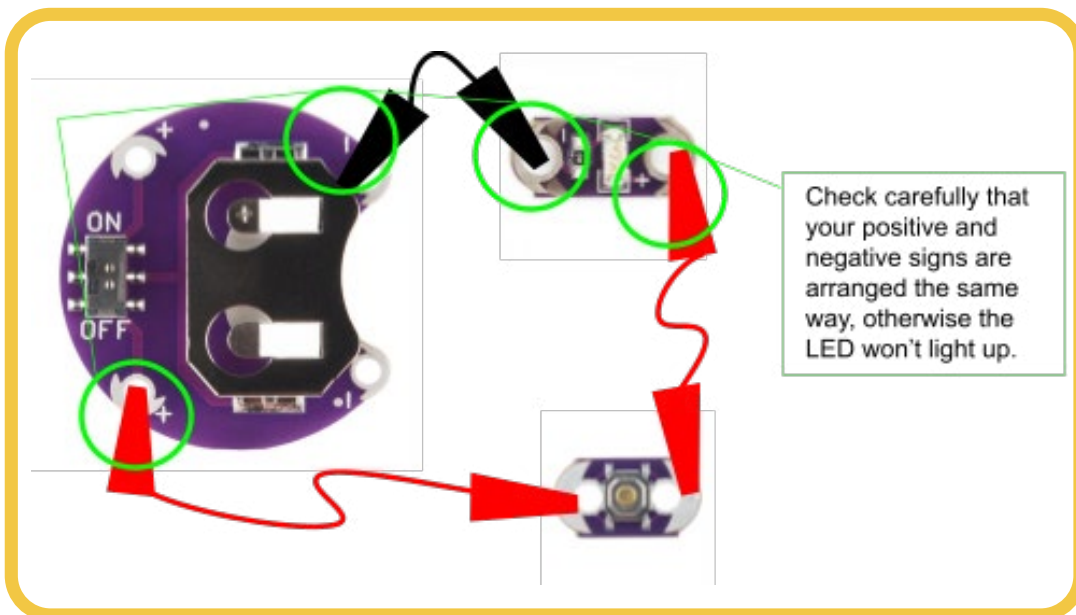

- 2 Next, let's make our own wearable switch using fabric and conductive fabric. This type of switch is called a 'sandwich switch' as we will have 3 layers of fabric sandwiched together to make our switch.

3



Making the sandwich switch: Cut three small rectangles of felt fabric (shown in white), and cut a hole slightly larger than your finger tip in the middle of one piece.

4



Cut two slightly smaller pieces of conductive fabric into L shapes, in rectangles but with a longer tab piece at one end (shown in grey)

5

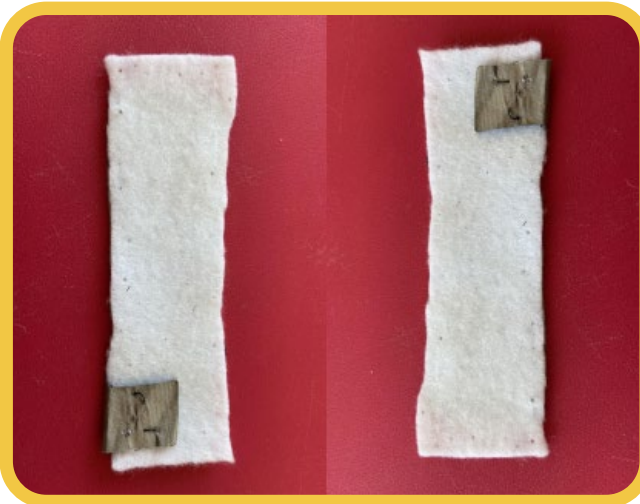

Lay one piece L-shaped of silver conductive fabric on top of a piece of felt. For the tab of the conductive fabric over the felt, then make a couple of small stitches with the needle and thread to hold the tab in place. Repeat this step to make two pieces

6

Next, we are going to make our sandwich. Place the piece with a hole on top of one of the other rectangles so that the conductive fabric shows through the hole. On top of that, place your other rectangle with the conductive fabric facing down towards the hole.



7



Next, stitch all layers of the sandwich switch together.

8

To use the switch, we can connect an alligator clip to the small piece of conductive fabric showing on each side of the switch, and press in the middle to activate it. We can replace the switch in the circuit we built earlier with the new switch we have just made.

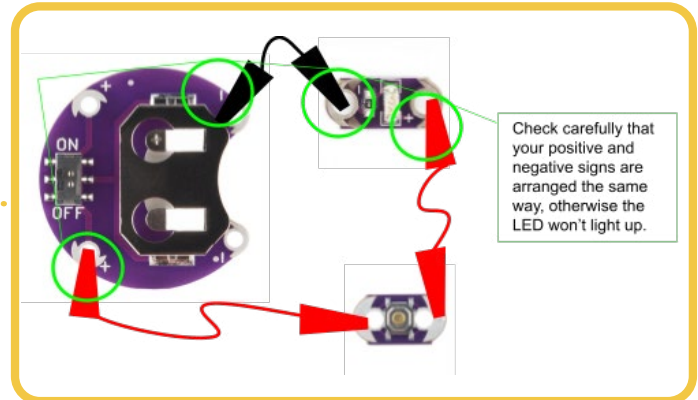
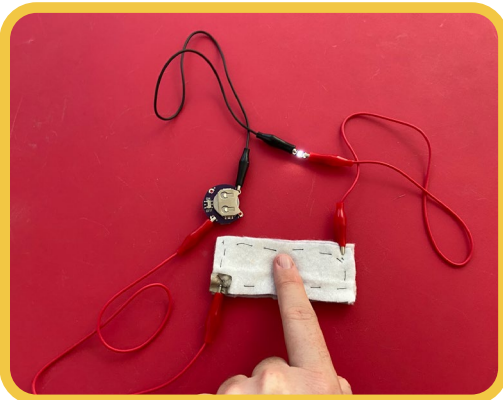

9

If you would like to use this switch in a wearable project, replace the alligator clips with conductive thread, and use regular thread to stitch the switch on to your project. You've now made a soft switch that can be used to control a light!

PILIMMAKSARNIQ

The concept of developing skills through observation, mentoring, practice, and effort.

What skills and knowledge did you acquire during this project?

What happens inside our switch when we press it in the middle? The two pieces of conductive material touch each other through the hole in the centre of our sandwich switch, allowing the electricity to flow to our light. Most switches work in a similar way. Some are designed to stay on, such as a slide switch. Some switches are only on while we press them- like the sandwich we made!

QANUQTUURUNGNARNIQ

The concept of being innovative and resourceful.

- In what ways were we resourceful to solve a problem while making this project?
- How was the switch that we made different to the switches that came with the kit?
- Are there things that are better about making our own electrical components?

POST-LESSON REFLECTIONS

Now that we have an understanding of what a switch is, let's consider other items in our environment can be used as a switch.

- Can we use two spoons?
- Would we need plastic spoons or metal spoons?
- Could a button or a snap work?
- What else could be made in to a switch?
- What worked?
- What didn't, and why?
- What to change for next time?

RESOURCES

Button and Switch Basics

<https://learn.sparkfun.com/tutorials/button-and-switch-basics/all>

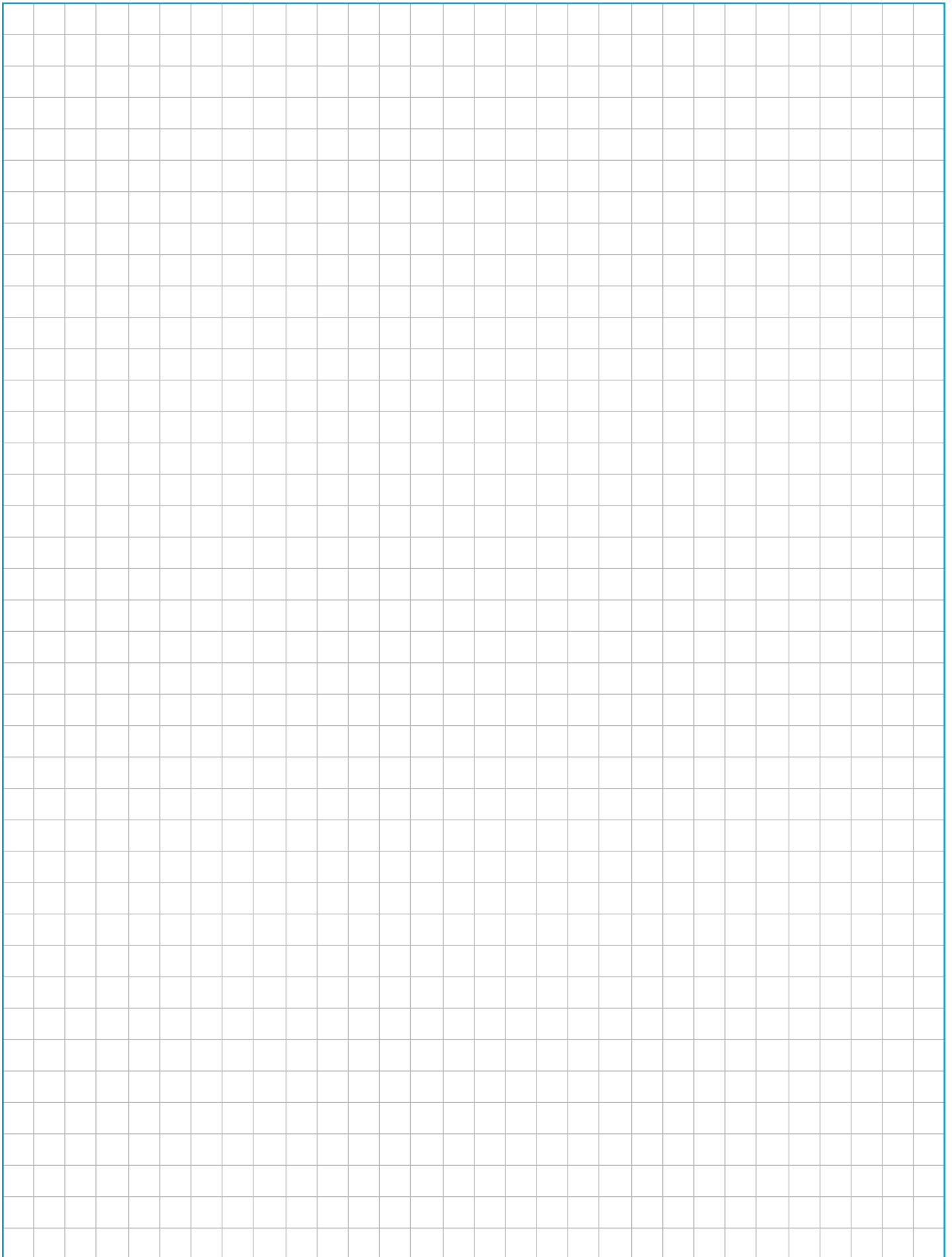

Beading & Circuits: Floral Design

IN THIS PROJECT, WE WILL CREATE BEADED ARTWORK THAT WILL

light up using the LilyPad E-sewing components such as LEDs, a battery and conductive thread. The design used in this activity is a donation by the artist @sarchristi to the #BeadThisInYourStyleChallenge.

i BEFORE YOU START

LEARNING GOAL(S):

- Explore the history of beading in Indigenous communities and contemporary applications
- Make connections to Inuit Qaujimajatuqangit (Inuit societal values)
- Design an E-sewing beading project
- Understand E-sewing circuit diagrams

SUCCESS CRITERIA:

You can create a parallel circuit with multiple LEDs using the LilyPad components.

VOCABULARY

Terminals, Tabs, Ends: All these words refer to the (+) and (-) connections on the LilyPad components. This is where the conductive thread is looped to connect them in a circuit. Many electronic components like these have polarity, meaning electric current can only flow through them in one direction.

Parallel Circuit: in a parallel circuit the current is divided into separate paths.



an LED with (-) and (+) tabs

MATERIALS

LilyPad E-Sewing Components:

- 1x LilyPad Battery Holder
- 1x Conductive Thread Bobbin
- 1x Coin Cell Battery --- CR2032
- 1x Needle Set
- 6x LilyPad LEDs

Printable Materials:

- [Spirit Berries article](#) (can be found on the USB)
- [Beading Pattern Template](#)

Craft Materials:

- 1x Black Felt
- 1x White felt (leftover from the Lilypad sewing kit)
- 1x Any colour felt
- 1x Black Thread Bobbin (non-conductive)
- 1x Sewing needles
- 1x Scissors

ESSENTIAL QUESTIONS FOR ACTIVITY

Q: Why doesn't the nylon thread conduct electricity?



THINKING ABOUT SWITCHES AND POWER

Read the article titled: [Spirit Berries](#) to learn about beading, technology and the work of Barry Ace. This article can be found on the flash drive or at <https://pinnguaq.com/stories/spirit-berries>.

The article tells us that with today's technology we can communicate better, so that we can share what we've learned with others for the common good of our communities. What Inuit Qaujimajatuqangit (Inuit societal value) does this relate to?

LET'S GET STARTED!

ACTION

1 Introduction: First we should gather the materials and ensure to have all the resources needed to complete this project.

RESOURCES CHECKLIST

Beading Supplies:

- Beading pattern/template
- Thread (nylon)
- Beads
- Beading Needles
- Beading felt
- Scissors
- Spare material (a t-shirt, dishcloth, extra felt if you have any)

Tech Components:

- Battery
- LilyPad battery holder
- LilyPad L EDs
- Conductive thread

2 Planning/Mapping: select a pattern that you would like to bead or draw your own on paper.

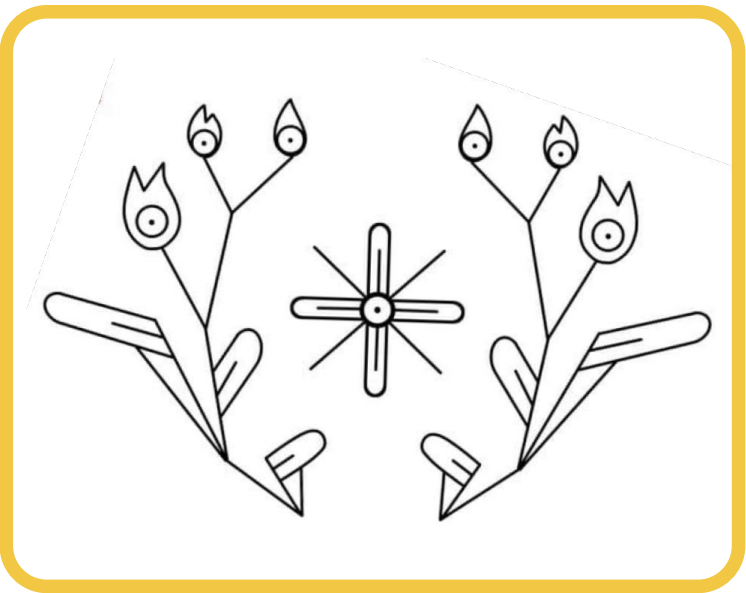

- 3 Identify parts you would like to highlight. Highlighted in yellow is where the LEDs will go on the template. This project requires six (6) LEDs in total.



- 4 Design a map of the layout of your circuit.

- We will need to assemble this circuit in parallel.
- In the diagram below the red lines indicate where the conductive thread will connect the positive (+) tabs of the LEDs.
- The black lines indicate where the conductive thread will connect the negative (-) tabs of the LEDs

Troubleshooting Tip: use the alligator clips to test out your circuit before sewing it to your project. Make sure all the LEDs light up. If they don't, make sure the LEDs are connected properly. Many electronic components like these have polarity, meaning electric current can only flow through them in one direction.

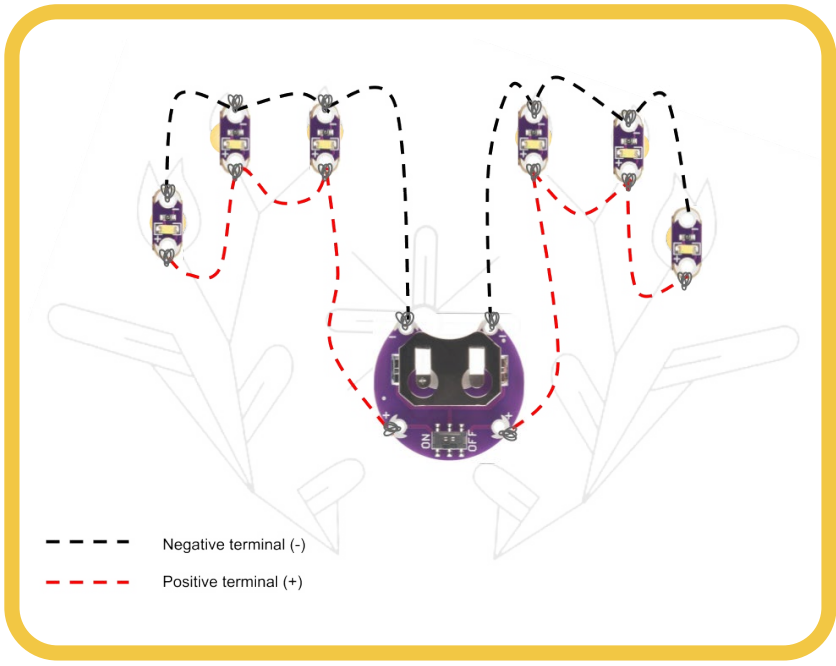

Here's a diagram identifying the orientation and placement of the LEDs and the battery holder. The broken lines indicate where the conductive thread will be sewn

5 **Creating the Project:** here we will assemble all the materials necessary to begin beading onto our chosen pattern.

WHIP OUT:

- One needle small enough to pick up and thread beads
- Another needle to attach the beads
- Nylon thread
- Scissors
- Beading felt
- Beads
- The pattern you would like to make
- Spare material (a t-shirt, dishcloth, extra felt if you have any)

- 6 **Two-needle Beading Technique:** cut two pieces of nylon thread about an arm's length. Starting with the first needle, thread the needle with one piece of nylon thread and tie the ends together in a knot. Repeat this step for the second needle.



- 7 Place your design on the beading felt and attach it securely to the felt so it doesn't move. You can use a needle and thread to make a few stitches around the pattern. If you have a stapler handy, this can be used as well. We will bead over the paper design. You can remove the paper when the project is finished by tearing it.

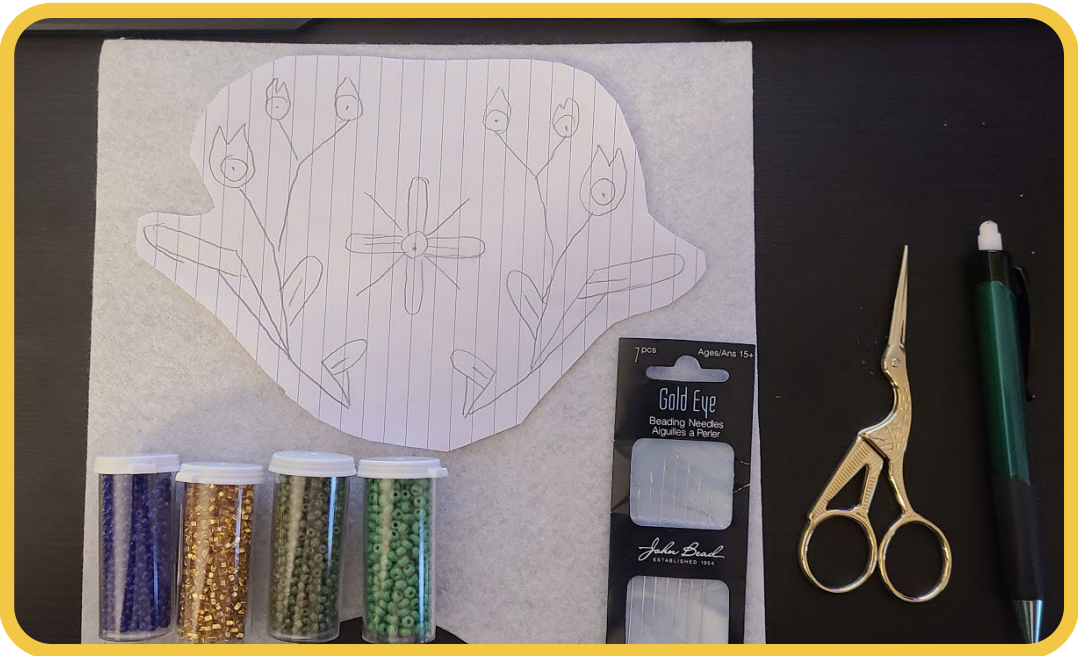

8

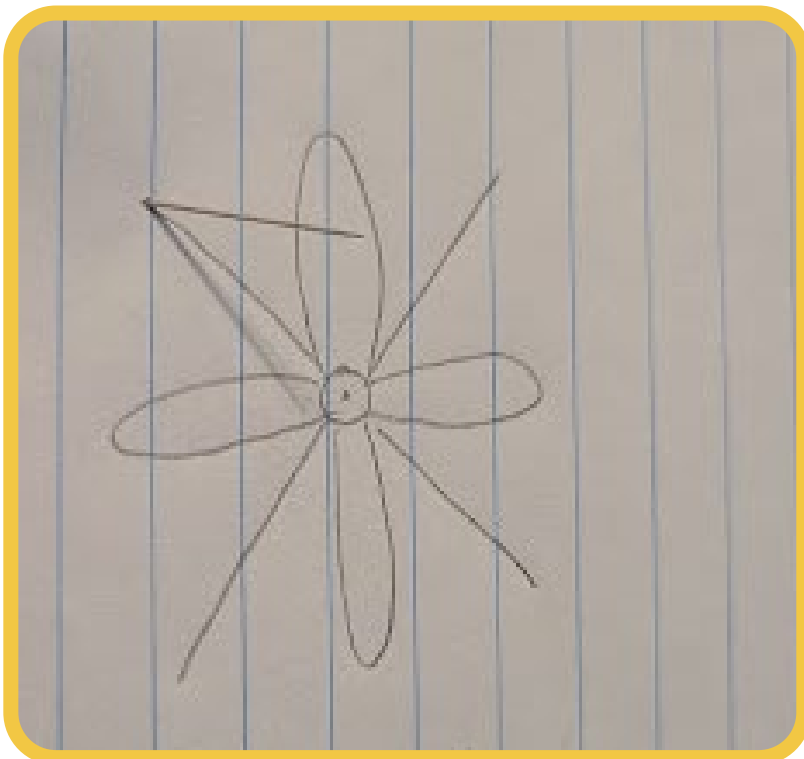

Begin with the smaller needle and find a spot anywhere on the pattern where you would like to start. Push the needle from the back of the project (the felt side) to the front, piercing the paper. Pull the thread through until the knot reaches the felt side. If your knot is too small it may pass through the felt and you will have to make a bigger knot.

9

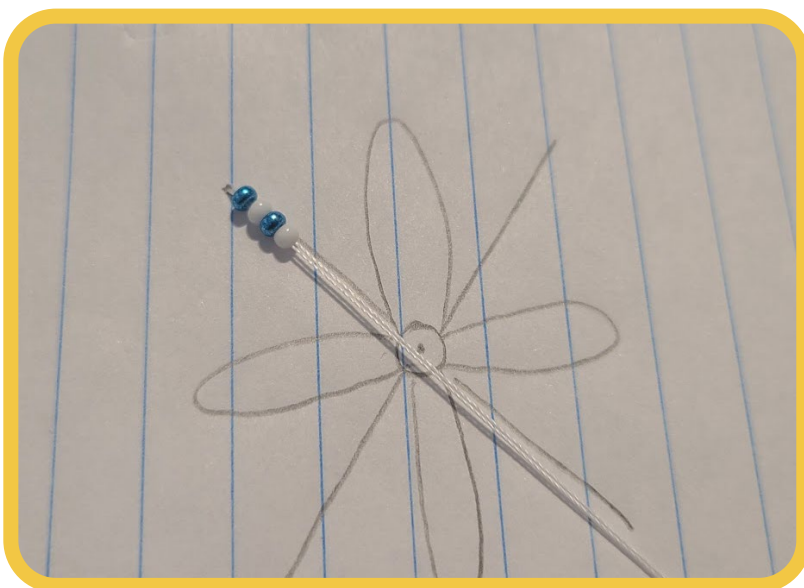

Pick up some beads, four or five to start and place them on the pattern following the lines. Pull the needle so the thread holding the beads is stretched out and taut. Using your free hand, push the beads towards the paper so they lay flat in a straight line. Hold these beads steady with your thumb on the thread.

10 Now we will secure the beads in place using the second needle we threaded earlier. With your free hand holding down the beads, grab the other needle and place it behind your project like we did in step 3. We want this needle to be near the first bead on the thread but it may take a few tries. Pull the thread through only once you're sure it's as close to the first bead as possible. Pull the thread through until the knot touches the felt.

11 This second needle will go over the line of beads and back through the paper and felt. This will create a loop that holds each bead in place. Place the needle on the other side of the beads between the first and second bead. Push through the paper and felt and pull it tightly. The first bead should be secure and shouldn't move.

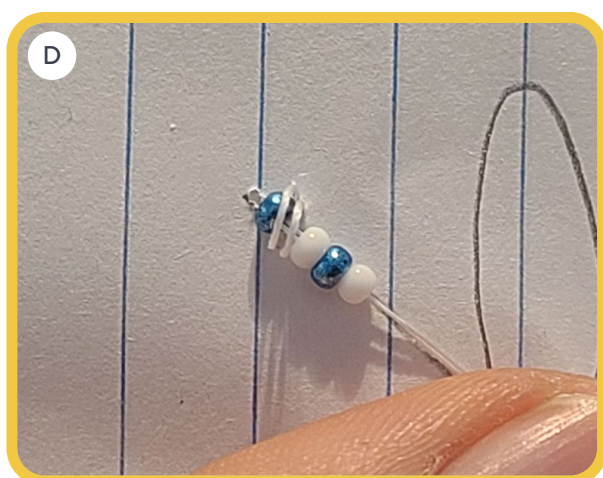
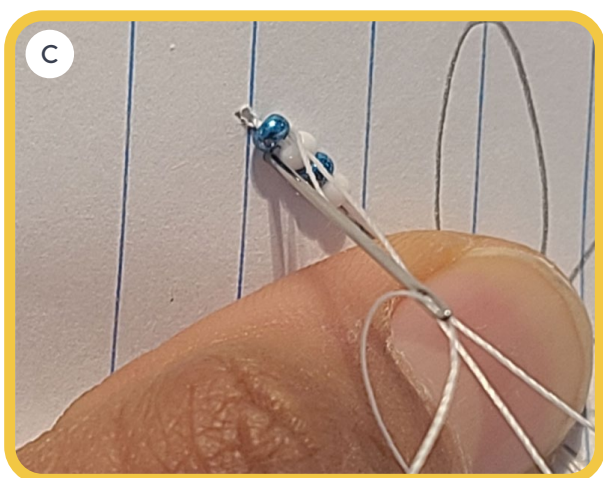
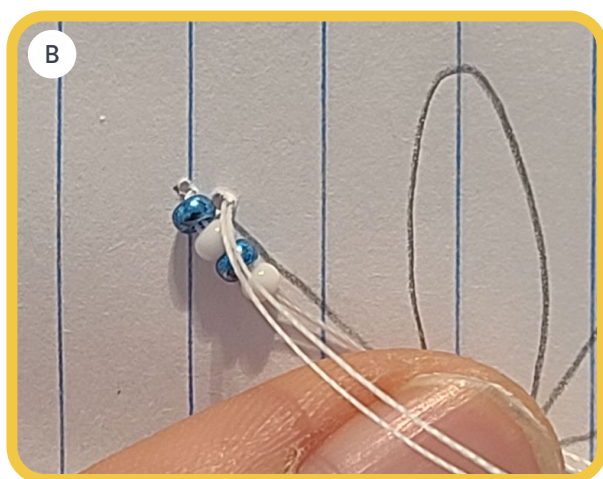
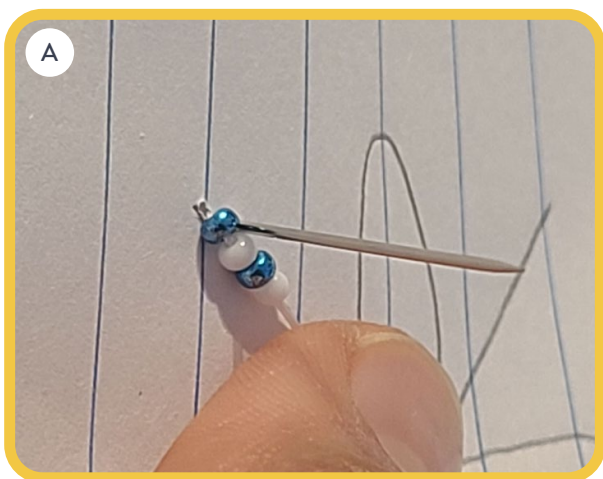

12 Repeat steps 10 & 11 until all the beads on the thread are secured to your project.

13 When you start to run out of thread on either needle, push the needle to the back side of your project and tie a knot. Make sure to always pull the thread tightly so there isn't any looseness. This will ensure the beads stay in place. Repeat from step 6.

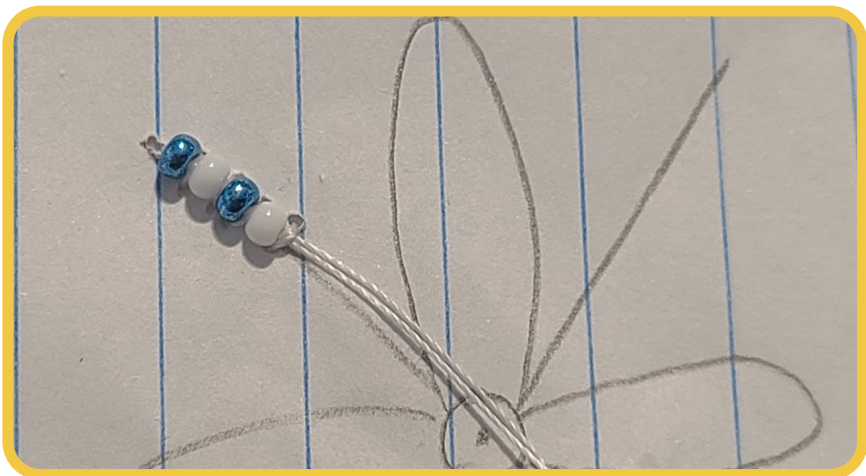

14 Remove the paper once it's no longer needed.

IMPORTANT: be sure to leave a space where you want to place the LEDs

15 **Adding the Components:** here, we will sew the circuit components to our project. We will refer to the circuit diagram for this project or the one you designed.

YOU WILL NEED:

- LilyPad LEDs
- Battery holder
- Conductive thread
- Non-conductive/nylon thread
- A needle
- Scissors

16 Ensure that your circuit and LEDs are functioning (see Troubleshooting Tips).

17 Thread your needle with the non-conductive nylon thread.

18



Place an LED on the front of your project. Secure it with regular thread. Repeat this step for each LED.

19 Place the battery holder behind the project and attach it.

20 Now we will use the conductive thread to connect the positive and negative terminals of each LED so that they are arranged in parallel.

21 Loop the conductive thread through the terminals of the LEDs.

22 Use a running stitch to connect them.

23 The final LED in each arrangement will connect to the battery holder and its corresponding terminals.

23 Turn on the switch located on the LilyPad battery holder on your project and watch it glow!

? PILIMMAKSARNIQ

The concept of developing skills through observation, mentoring, practice, and effort.

POST-LESSON REFLECTIONS

- What worked?
- What didn't, and why?
- What to change for next time?

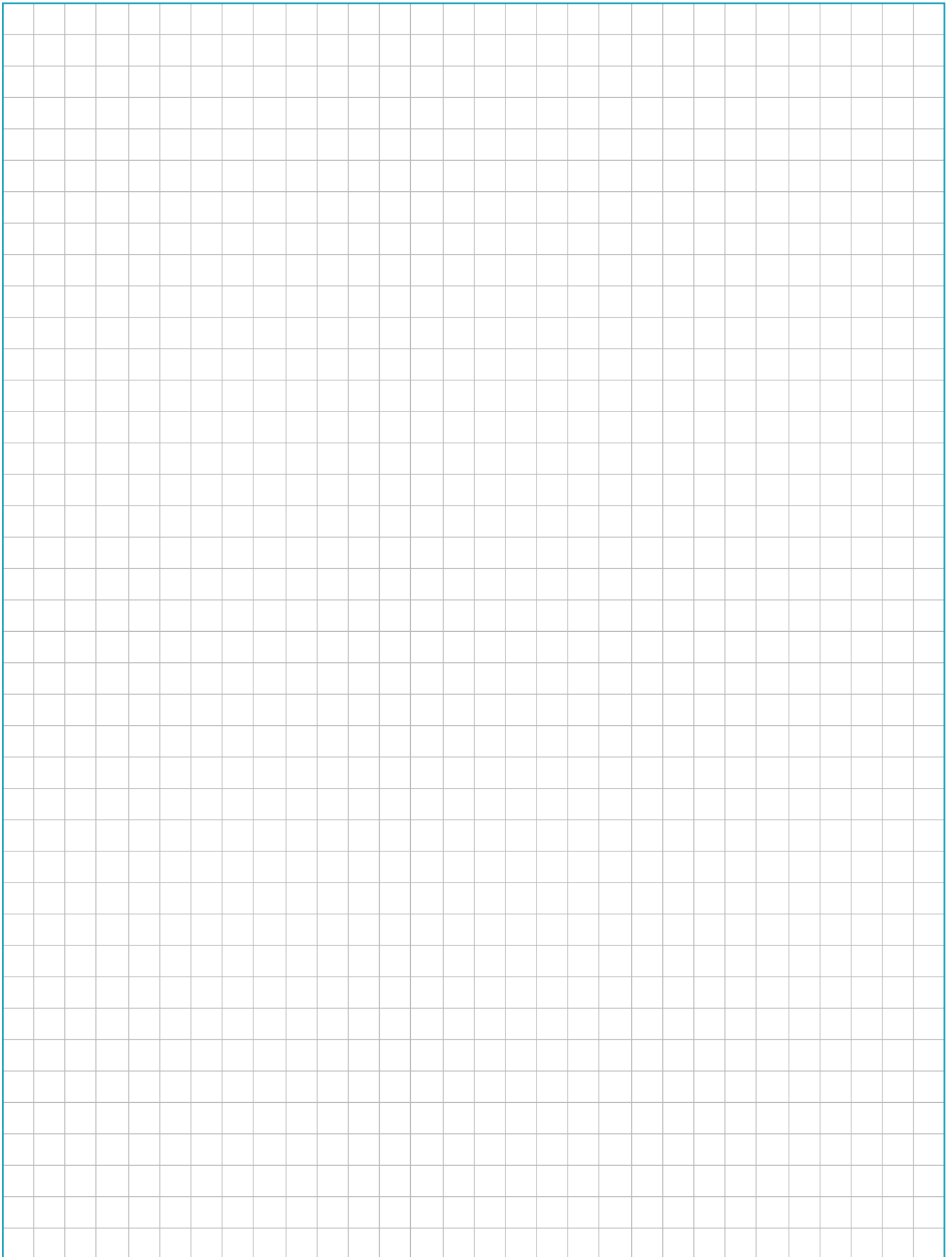

Beading and Circuits

BEFORE YOU START

LEARNING GOAL(S):

- Recreate the LilyPad ESewing Kit circuit incorporating beads.

SUCCESS CRITERIA:

- You understand how to plan and execute an art activity incorporating beads and circuits.
- You can incorporate circuits into your art activities and beading activities.

MATERIALS

LilyPad E-Sewing ProtoSnap Kit including:

- 1x LilyPad E-Sewing ProtoSnap
- 1x Conductive Thread Bobbin
- Sewing Kit

ESSENTIAL QUESTIONS FOR ACTIVITY

Why don't the beads react to the conductive thread? (insulators)

Why do the LEDs react to the conductive thread? (conductivity)

What happens if we remove the battery?

MINDS-ON

Read the article titled: [Spirit Berries](#) to learn about beading, technology and the work of Barry Ace. Review introduction to circuits lesson.

LET'S GET STARTED!

 ACTION

PLANNING / MAPPING

1 Select a pattern that you would like to bead.

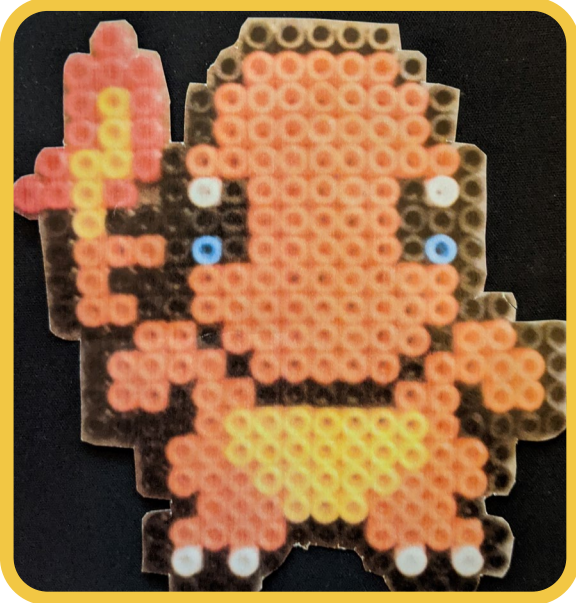

2 Identify parts you would like to highlight.

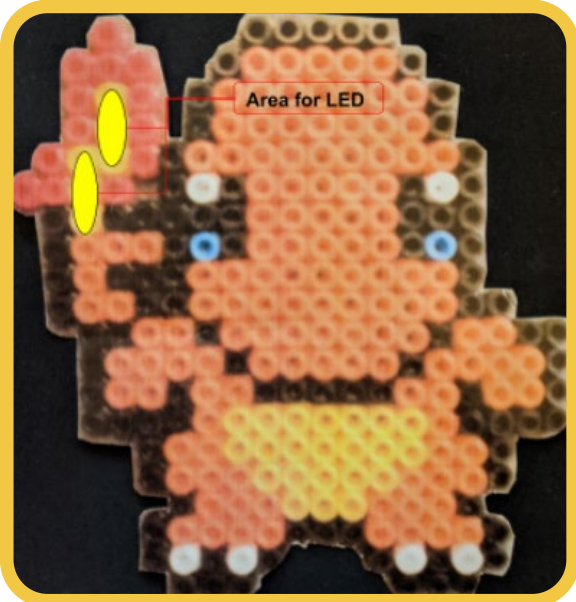

3 **Resources Checklist:** ensure we have all the resources you need.

- Bead template
- LilyPad LED's
- LilyPad Battery
- LilyPad Switch
- Thread/Nylon
- Beads
- Conductive thread
- Beading Needles
- 9x6 Piece of Felt
- Scissors

GUIDE (PLEASE READ THROUGH BEFORE STARTING PROJECT)

1 Select the piece of felt you would like to use to bead your pattern on.

2 Draw a guide that would be helpful to sew beads on to felt. *Example - Sew pattern on to felt or draw lines you would like to follow.*

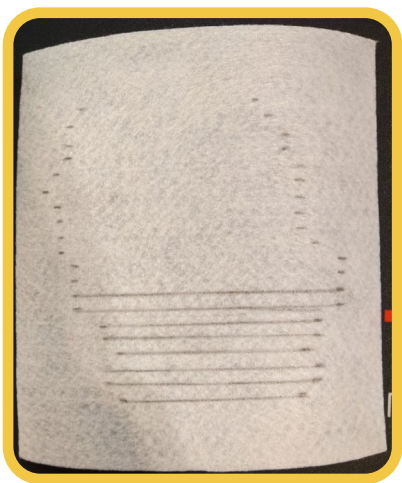

3 I got the lines above, by placing my template on the felt.

4 I then made marks at the center of the beads and then connected the ends. This helped to sew my beads straight.

5 Now that we have our pattern guide on our Felt we will select our beads. The pattern I used made it easy to know what colour beads I would need and how many of the colours I would need. **Note: If you do not have bead colour that you would like to use on pattern substitute it with another colour. I didn't have white beads so I used pink at places that required white.**

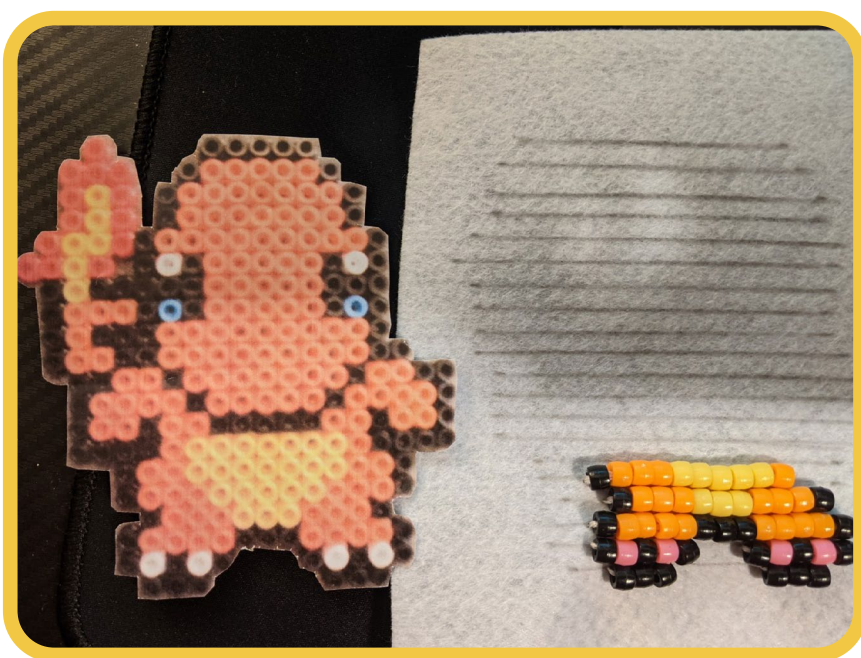

6 Thread your needle with the thread/nylon provided.

7 Select your start point and if you're an experienced beader you can start beading with your preferred method (*I experimented with a few methods before I started which you can follow*).

CREATING BEADED ART FROM TEMPLATE

- 1 First pierce the back side of your Felt up to the front with your needle.



- 2 Pull your needle up as high enough so that there is just a tiny piece of thread left on the back.

- 3 Pierce your felt as close as possible to your first piercing but front to back this time.

- 4 Pull all the way down so that there's no extra thread above but not so much as to pull the piece from the button out. If you pull too hard your thread might come loose.



- 5 Repeat this step two or three times so that eventually you would have created a knot and your thread will be firmly attached to your felt.

6



If your knot ends on the back of the felt, pierce the felt up then select a bead or beads following your pattern colour guide and insert it into the needle. If your knot ended on the front of the felt add the bead or beads.

7



Slide the bead or beads down on to the felt and arrange it or them then pierce your felt down as close as possible to the bead or beads. **NOTE: I used one bead at a time, this helped me to ensure my bead would be secure and wouldn't move around too much when I added other beads.**

8



Next pierce your needle up your fabric behind the last bead you just secured and through it, then add your new bead or bead and sew them down.

- 9 Repeat step 8, adding beads and connecting them until your pattern is complete. Note - Remember to leave the room to sew in your led lights.

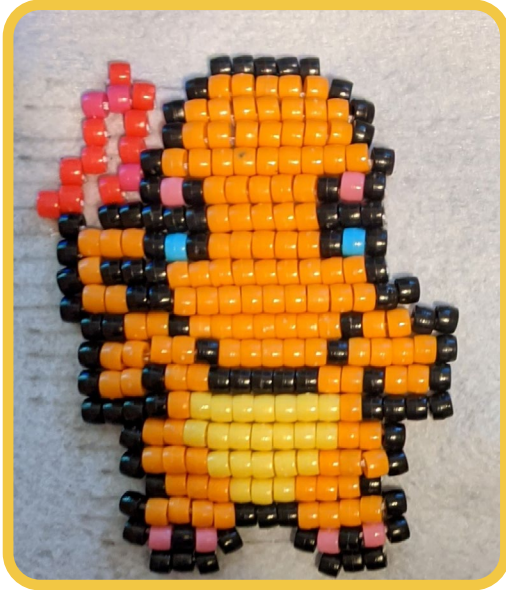

- 10 When you start to run out of thread on either needle, push the needle to the back side of your project and tie a knot. Make sure to always pull the thread tightly so there isn't any looseness. This will ensure the beads stay in place. Repeat from step 1.

ADDING LEDs TO BEADED ART

- 1 Flip your beaded project and map out your circuit path.

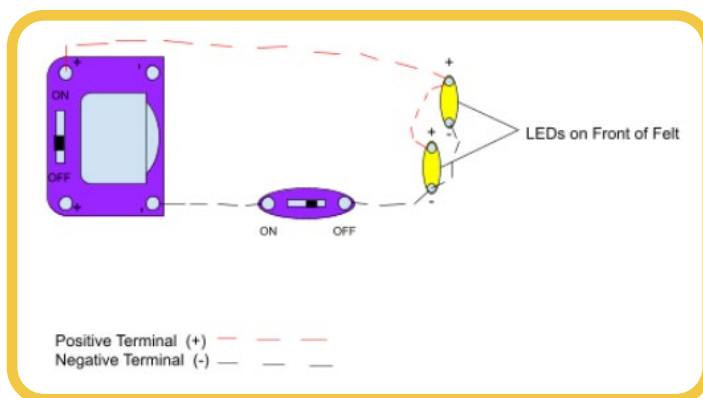

- 2 Using nylon thread sew the battery onto felt. Use the unused terminals.
- 3 Using the **conductive thread** (silver thread in LilyPad box), starting with the negative terminal follow the diagram and sew the switch down onto the felt.
- 4 Without breaking the conductive thread sew down the negative terminals of the LEDs on the front side of the felt.
- 5 After securing the second LED make a knot and cut end the sew.
- 6 With a new piece of conductive thread follow the diagram and follow the positive line on the diagram.
- 7 Once both LEDs are sewn down, break the thread.
- 8 Flip your switches on and tada your beaded light project is done.

? QANUQTUURUNNARNIQ

The concept of being innovative and resourceful.

WRAP UP AND CHECK FOR UNDERSTANDING

- Did part of this project need a resourceful solution to a problem?
- How can the knowledge and skills acquired during this project serve my community?

POST-LESSON REFLECTIONS

- What worked?
- What didn't, and why?
- What to change for next time?

📖 RESOURCES

Spirit Berries

<https://pinnguaq.com/stories/spirit-berries>

Bead This in Your Style

<https://www.instagram.com/beadthisinyourstyle/?hl=en>

Character Design and Pixel Art

https://docs.google.com/presentation/d/1wIVuyIIJEi3trgdmWsXFCJKN1Nm_bxqF/edit#slide=id.p2

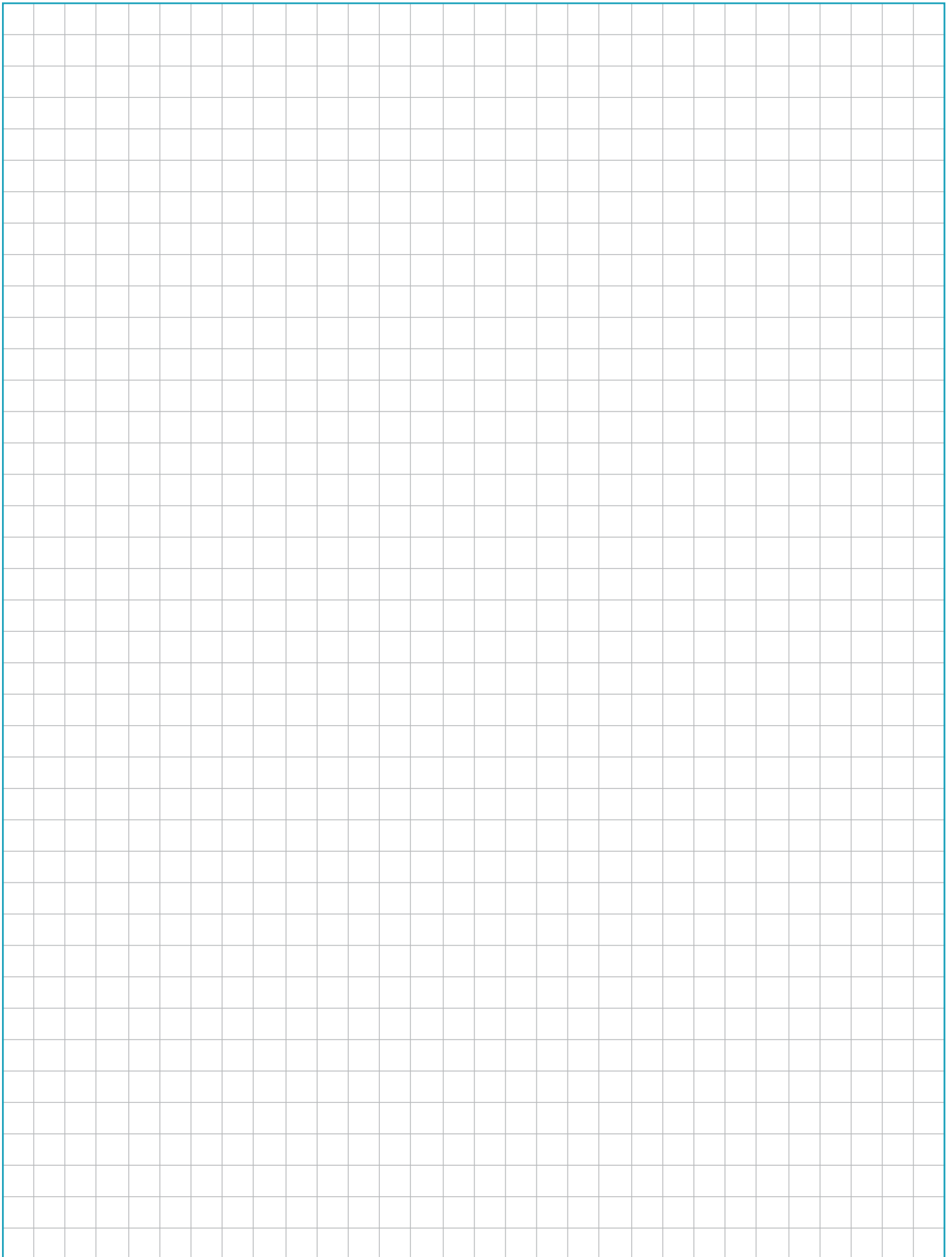

Stories in the Sky!

WE RECREATE CONSTELLATIONS USING LEDS IN A CIRCUIT TO TELL A STORY.

BEFORE YOU START

LEARNING GOAL(S):

- Learn about constellations and storytelling
- Learn about parallel circuits

SUCCESS CRITERIA:

- You can design and create a parallel circuit using e-textiles
- You can understand how to incorporate circuits in stories and artistic presentations

VOCABULARY

Parallel circuit: in a parallel circuit, the current is divided into separate paths.

Terminals, Tabs, Ends: All these words refer to the (+) and (-) connections on the Lilypad components. This is where the conductive thread is looped to connect them in a circuit. Many electronic components like these have polarity, meaning electric current can only flow through them in one direction.



an LED with (-) and (+) tabs

ESSENTIAL QUESTIONS FOR ACTIVITY

What would happen if we inserted the battery the wrong side up?

What other constellations can we use instead of the caribou?

How would this activity work if we used a series circuit?

 ACTION

INTRODUCTION

- 1 We will design and create a circuit to tell a story about stars and constellations. The constellation in this project is Tukturjuk, also known as the Big Dipper.



- 2 This project will use a LilyTiny board. This component has a tiny microcontroller on it to control the flow of electricity in the circuit. When the LEDs are connected to the terminals they will flash in different patterns!

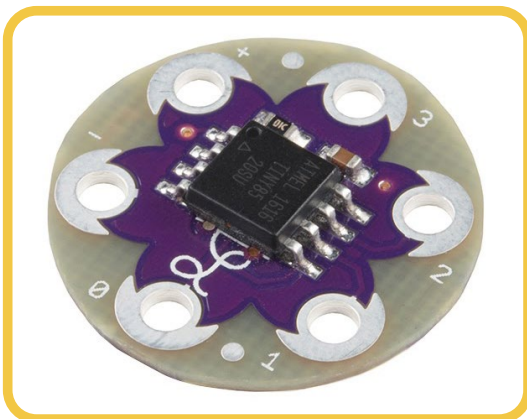

3 Resources Checklist: Ensure we have all the resources you need.

Craft Supplies:

- Black Felt
- White felt (leftover from the Lilypad sewing kit)
- Any colour felt
- Thread (non-conductive) (Ideally black)
- Sewing needles
- Scissors

Tech Components:

- Battery
- LilyPad battery holder
- LilyPad LEDs
- Conductive thread
- LilyTiny

PLANNING/MAPPING

1 Tukturjuk is a constellation made up of 7 stars so we will need 7 LEDs for this project. Copy the pattern to the black felt where you would like the constellation to shine. I've chosen the middle-top part of the felt.

2 **Design a map of the circuit:** The LilyTiny will control the flow of power to the LEDs, therefore it must connect to the terminals of the battery and the LEDs. Notice how the LEDs have been grouped into 3 sets. No matter how many LEDs are included in your design, you will want to divide them into three groups as shown. The '-' tab of every single LED in your constellation connects to the rest with conductive thread, as well as the '-' tab on the LilyPad Tiny and the '-' tab on the battery holder.

- 3 The '+' tabs will be treated differently. For each group of LEDs, you will connect all the '+' tabs inside that group with conductive thread, and then connect them to either pins 0, 1, or 3. We are not using pin 2 as the animation is not ideal for this design.
- 4 For power, you will also need to connect the '+' tab of the battery to the '+' tab of the LilyTiny.
- 5 This configuration is an example of a parallel circuit.
- 6 The red lines indicate where the conductive thread will connect the positive (+) tabs.
- 7 The black lines indicate where the conductive thread will connect the negative (-) tabs.

TROUBLESHOOTING TIP: Use the alligator clips to test out your circuit before sewing it to your project. Make sure all the LEDs light up. If they don't, make sure the LEDs are connected properly. Many electronic components like these have polarity, meaning electric current can only flow through them in one direction.

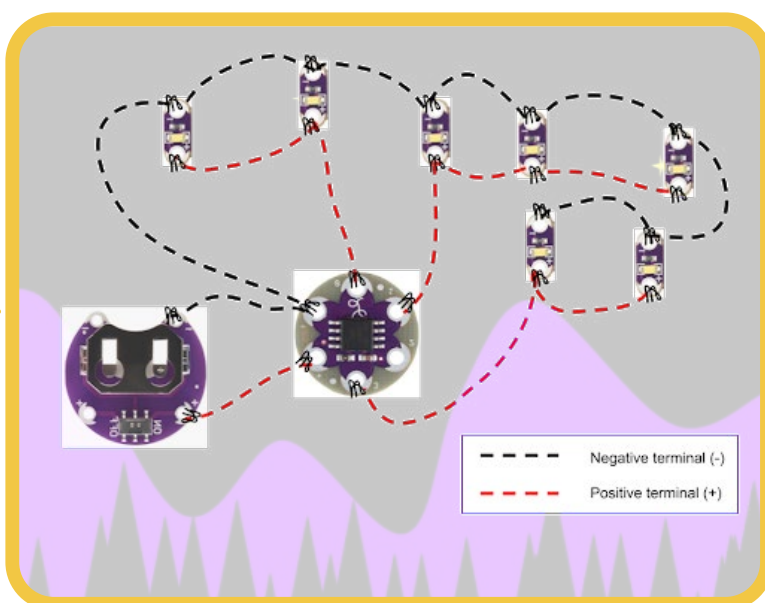

CREATING THE PROJECT

1 Arranging the Circuit: here, we will sew the circuit components to our project. Refer to the circuit diagram for this project or the one you designed in the Planning/Mapping section

- A** Ensure that your circuit and LEDs are functioning (see Troubleshooting Tips).
- B** Thread your needle with the non-conductive nylon thread.
- C** Place an LED on the back of your project. Secure it with regular thread. Repeat this step for each LED and the battery holder.
- D** First, use the conductive thread to connect the negative terminals of each LED by looping the conductive thread through the terminals.
- E** Use a running stitch to connect them.



- F** The final LED will connect to the negative terminal on the LilyTiny component.
- G** Connect the positive terminals using the circuit diagram.

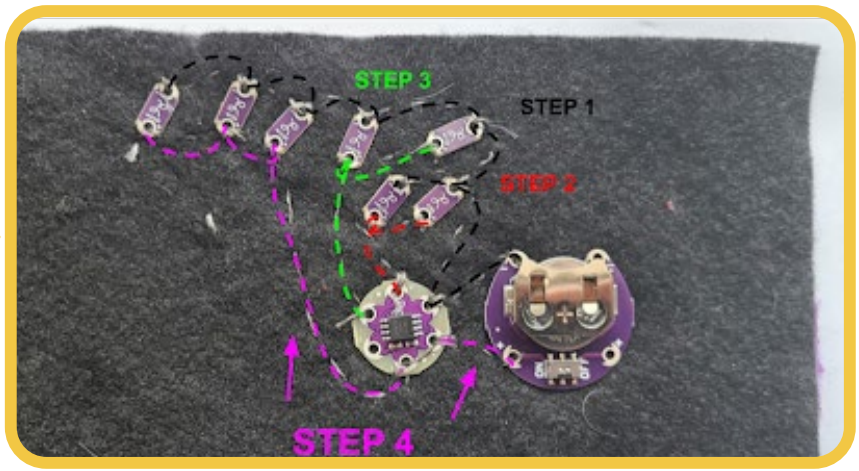
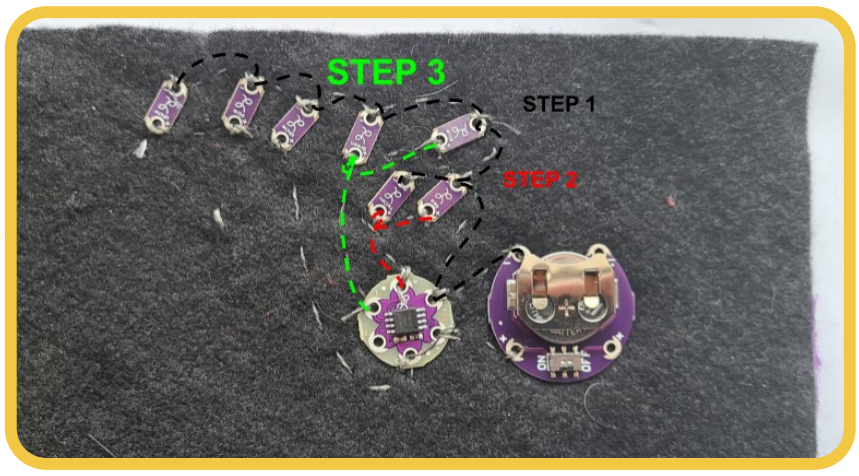

H Switch on your project and watch it glow!

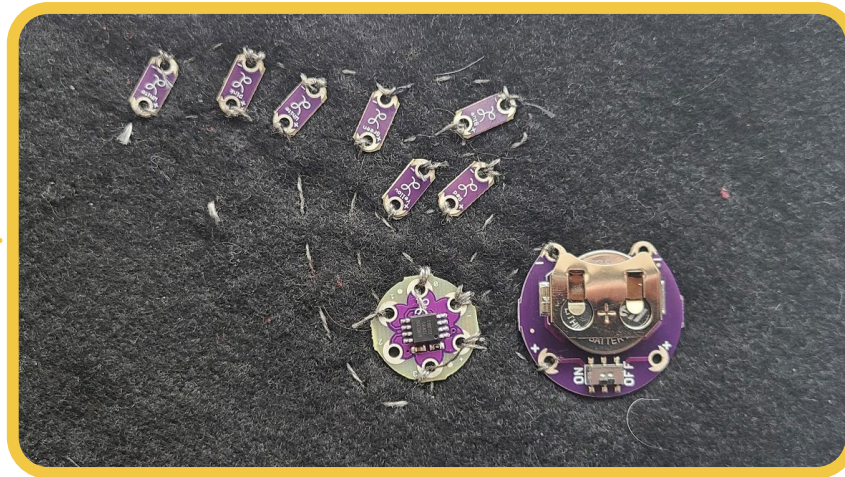

2 Add the Story Elements: Here we will cut and arrange the elements of our night sky scene:

- The night sky: Black felt
- Tuktu (caribou): White felt
- Landscape elements such as mountains, hills, trees, rivers

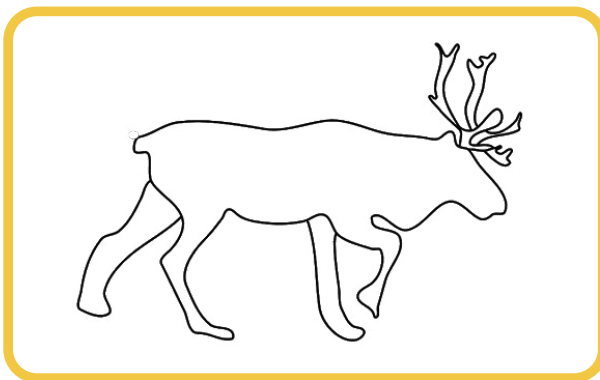

A Gather the craft materials from the resource checklist and clear a space to work safely.

B To create the story elements, you can draw them on paper first before cutting any material. Place the paper on the felt and trace the shape or cut the material following the template.

- C Sew the pieces of felt onto the black felt to secure them in place – any stitch you know of will do.



- D Now you can share your stories of the night sky with your own flashing constellation!



? CONSOLIDATION

WRAP UP AND CHECK FOR UNDERSTANDING

Avatittingnik kamatsiarniq:

How do you show respect and care for the land, animals and the environment?

POST-LESSON REFLECTIONS

- What worked?
- What didn't, and why?
- What to change for next time?

📖 RESOURCES

QIA- Free Inuktitut Books for Families

<https://www.qia.ca/free-inuktitut-books/>

Constellations: Connect the Dots in the Sky! SciShow Kids

<https://www.youtube.com/watch?v=1sZ15SUEs9w>

Indigenous Peoples Astronomy: How the lost constellations of Indigenous North Americans can connect culture, science, and inspire the next generation of scientists.

<https://www.sciencefriday.com/articles/indigenous-peoples-astronomy/>

Inuktitut Ilinniaqta: Inuktitut vocabulary words about astronomy

<http://inuktitutilinniaqta.com/astronomy/>

Aboriginal Astronomy: Navigation & Star Maps Aboriginal Australians use the stars to navigate across the continent

<http://www.aboriginalastronomy.com.au/content/topics/starmaps/>

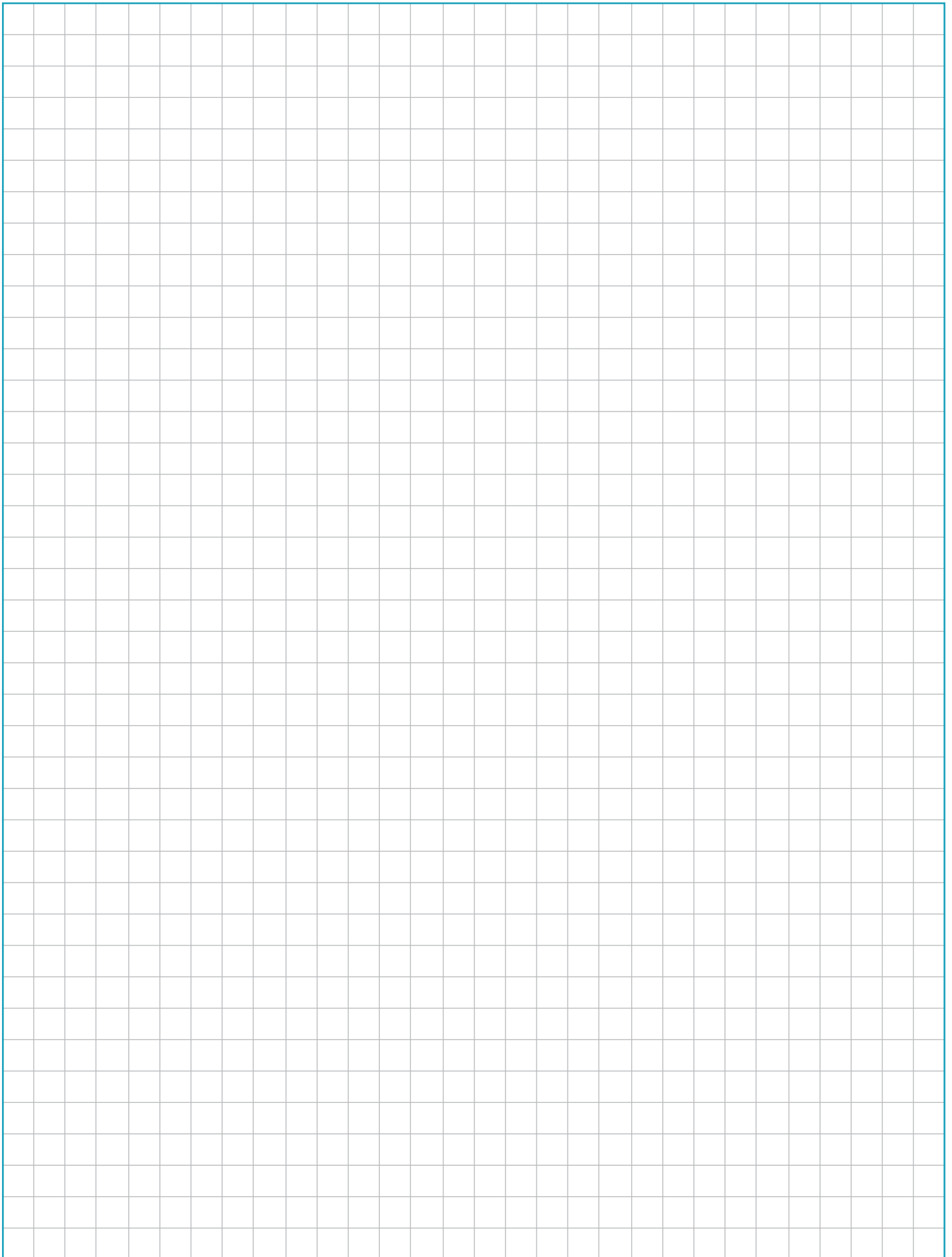



Way to Go!

THANK YOU FOR GETTING CREATIVE WITH THE STITCHES AND SWITCHES KIT.

We hope you enjoyed learning about sewing, circuits and Inuit principles and values. If you'd like to keep creating interactive projects and art, find the book *Make: Wearable Electronics* by Kate Hartman. You will find examples and step-by step instructions that explore different materials and techniques in e-textiles.

Continue creating and telling your own stories!

- Your Friends at Pinnguaq

REMEMBER TO SHARE THEM WITH US BY TAGGING
[@PINNGUAQ](#) AND POSTING [#LEARNWITHPINNGUAQ](#).